

Shaft Speed : 2850 rpm

Outlet : 80mm, 3in

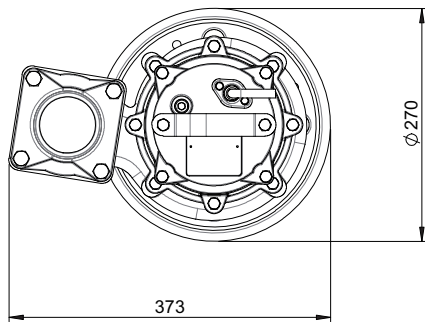

OUTPUT	HEAD	FLOW
2.2 kW	Rated : 10m, 33ft	Rated : 5 l/s, 79 gpm
3 HP	Max : 15m, 49ft	Max : 13 l/s, 211 gpm

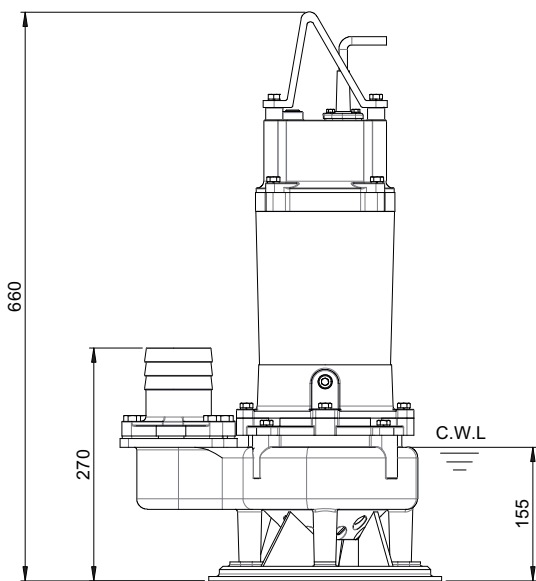

Weight : 43kg / 95 lbs

Pump Type		Electric Submersible Pumps
		3-Phase
Motor	Type	Induction Motor
	Poles	2 Pole
	Insulation	Class F
	Protector	Circle Thermal Protector
	Starter	D.O.L.
Lubricant		Food Grade (ISO VG32)
Impeller Type		Vortex
Shaft Seal		Double Mechanical Seal
		Silicon Carbide VS Ceramic / Carbon
Bearings		C3 Shielded ball bearings
Cable		H07RNF
		Length: 10m (33ft) or longer upon request.
Materials	Pump Casing	Gray Iron
	Impeller	Gray Iron
	Motor Frame	Gray Iron
	Motor Shaft	Stainless Steel
	Agitator	Ductile Iron
Max. Liquid Temperature		104°F (40°C)
Max. Submersion Depth		66ft (20m)
pH Range		pH 5 - pH 8